

**67X-001 +
67X-011 +**

1 = Messstelle für Temp.-Messung
1 = measuring point for temperature measurement

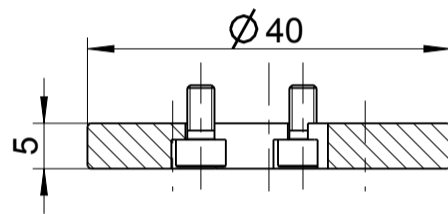

Flansch inkl. Befestigungsschrauben
flange incl. cylinder-screws
4451812

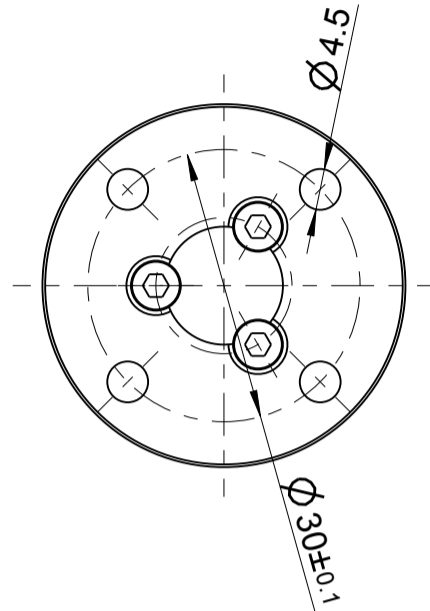
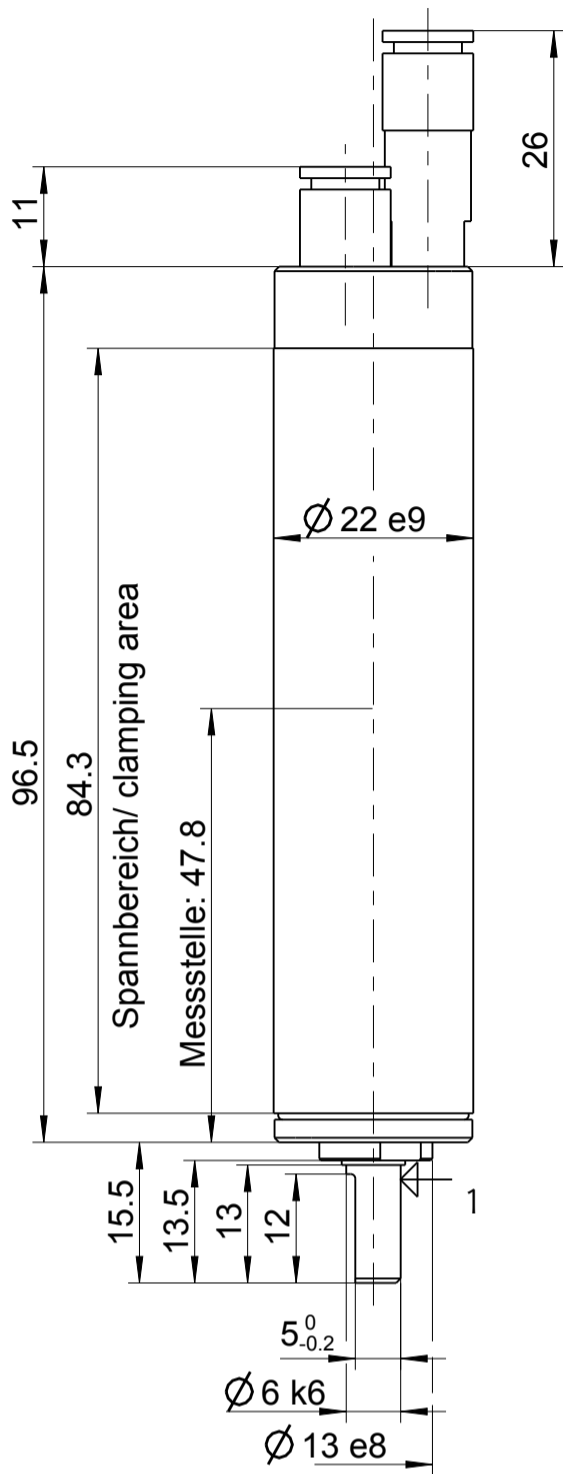
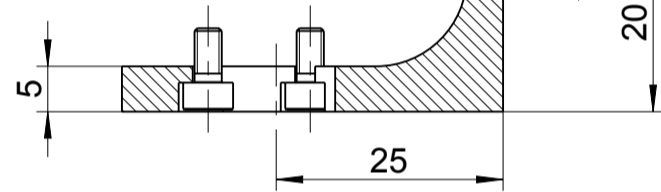
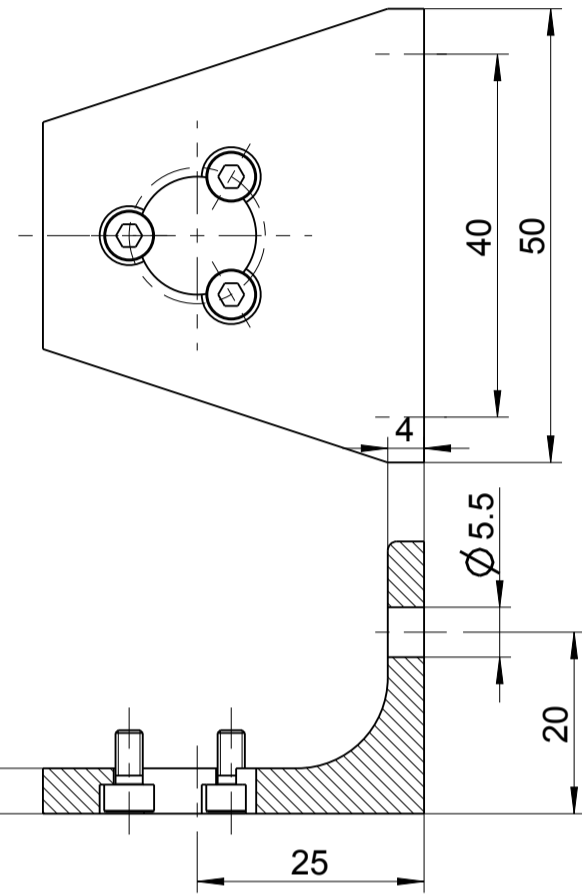

Fuß inkl. Befestigungsschrauben
foot incl. cylinder-screws
4451802

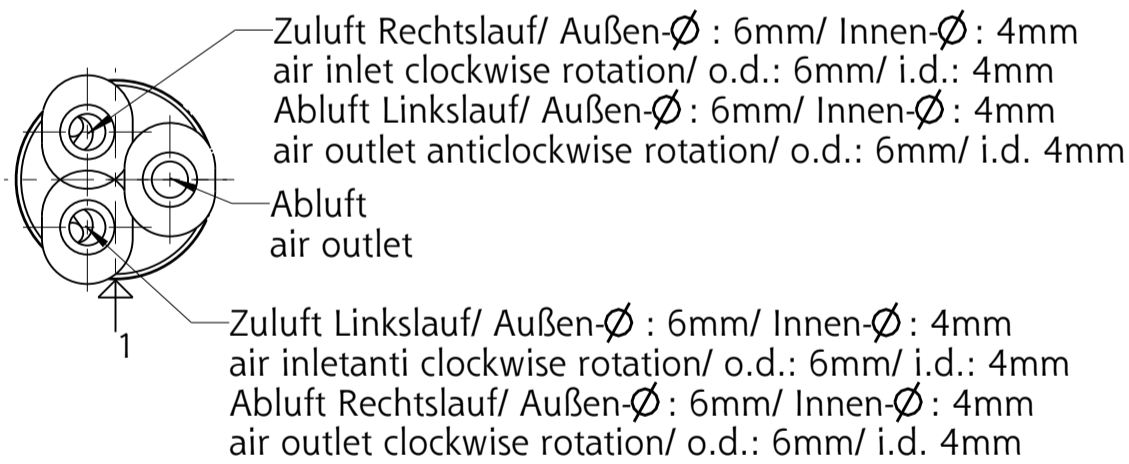

Schalldämpfer für Umsteuerbetrieb
Silencer for reversible
446354A

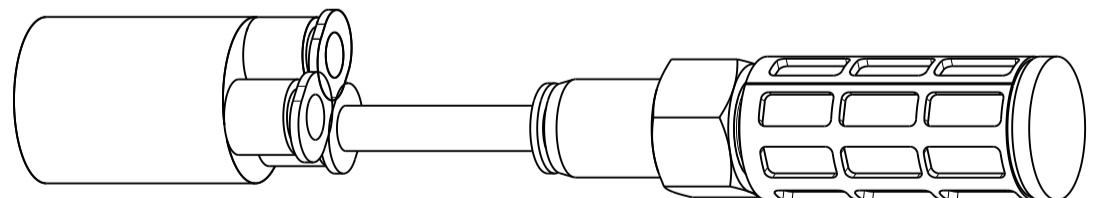

Schalldämpfer für Rechts- oder Linkslauf
Silencer for clockwise oder anticlockwise rotation
446354B

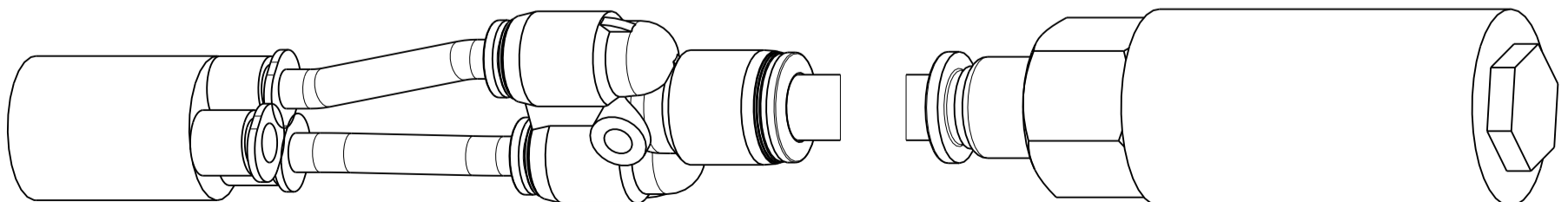

+ gilt auch für Nachsetzzeichen/ also applies for suffixes - C/M/Z/R/L

Typ / type

67X-0X1 +

DEPRAG

MASSBLATT / DIMENSION SHEET

110968

drw	2.2
asm	1.3